



N53AJ52
5MP Fixed Network Eyeball Camera
Quick Installation Guide

V1.0.1

Dahua Technology USA Inc.



Foreword

General

This manual offers reference material and general information about the basic operation, maintenance, and troubleshooting for a Dahua Camera. Read, follow, and retain the following safety instructions. Heed all warning on the unit and in the operating instructions before operating the unit. Keep this guide for future reference.

Safety Instructions

The following categorized signal words with defined meaning might appear in the Guide.

Signal Words	Meaning
 WARNING	Indicates a medium or low potential hazard which, if not avoided, could result in slight or moderate injury.
 CAUTION	Indicates a potential risk which, if not avoided, could result in property damage, data loss, lower performance, or unpredictable result.
 NOTE	Provides additional information as the emphasis and supplement to the text.

Revision History

No.	Version	Revision Content	Release Time
1	V1.0.0	First Release.	January 2019
2	V1.0.1	Revised for North America	July 2019

Privacy Protection Notice

As the device user or data controller, you may collect personal data such as face images, fingerprints, license plate number, email address, phone number, GPS location and other sensitive or private information. You must ensure that your organization is in compliance with local privacy protection laws and regulations to protect the legitimate rights and interests of other people by implementing measures include but not limited to: providing clear and visible identification to inform data subject the existence of surveillance area and providing related contact

About the Guide

- This user guide has been compiled with great care and the information it contains has been thoroughly reviewed and verified.
- The text was complete and correct at the time of printing. This guide may be periodically updated to reflect changes to the product or to correct previous information and the content of this guide can change without notice.
- If you encounter an error or have any questions regarding the contents of this guide, contact customer service for the latest documentation and supplementary information.
- Dahua accepts no liability for damage resulting directly or indirectly from faults, incompleteness, or discrepancies between this guide and the product described. Dahua is not liable for any loss caused by installation, operation, or maintenance inconsistent with the information in this guide.
- All the designs and software are subject to change without prior written notice. The product updates may cause some differences between the actual product and the Guide. Please contact the customer service for the latest program and supplementary documentation.
- Video loss is inherent to all digital surveillance and recording devices; therefore Dahua cannot be held liable for any damage that results from missing video information. To minimize the occurrence of lost digital information, Dahua recommends multiple, redundant recording systems, and adoption of backup procedure for all data.
- All trademarks, registered trademarks and the company names in the Guide are the properties of their respective owners.
- Please visit our website, contact the supplier or customer service if there is any problem occurred when using the device.
- Contact the supplier or customer service if you encounter any issue while using this unit.

FCC Information

This device complies with part 15 of the FCC Rules. Operation is subject to the following two conditions:

- This device may not cause harmful interference;
- This device must accept any interference received, including interference that may cause undesired operation.

FCC compliance

This equipment has been tested and found to comply with the limits for a digital device, pursuant to part 15 of the FCC Rules. These limits are designed to provide reasonable protection against harmful interference. This equipment generates uses and can radiate radio frequency energy and, if not installed and used in accordance with the instruction manual, may cause harmful interference to radio communication. However, there is no guarantee that interference will not occur in a particular installation. If this equipment does cause harmful interference to radio or television reception, which can be determined by turning the equipment off and on, the user is encouraged to try to correct the interference by one or more of the following measures:

- Reorient or relocate the receiving antenna.
- Increase the separation between the equipment and receiver.
- Connect the equipment into an outlet on a circuit different from that to which the receiver is connected.
- Consult the dealer or an experienced radio/TV technician for help.

Legal Notices

Copyright

This user guide is ©2020, Dahua Technology USA Inc.

This user guide is the intellectual property of Dahua Technology USA Inc. and is protected by copyright. All rights reserved.

Trademarks

All hardware and software product names used in this document are likely to be registered trademarks and must be treated accordingly.

Important Safeguards and Warnings

This chapter describes the contents covering proper handling of the device, hazard prevention, and prevention of property damage. Read these contents carefully before using the device, comply with them when using, and keep it well for future reference.

Installation and Maintenance Professionals Requirements

- All installation and maintenance professionals must have adequate qualifications or experiences to install and maintain CCTV systems and electric apparatus, and to work above the ground. The professionals must have the following knowledge and operation skills:
- Basic knowledge and installation of CCTV systems.
- Basic knowledge and operation skills of low voltage wiring and low voltage electronic circuit wire connection.
- Basic knowledge and operation skills of electric apparatus installation and maintenance in hazardous sites.

Power Requirements

- Install the unit in accordance with the manufacturer's instructions and in accordance with applicable local codes.
- All installation and operation must conform to your local electrical safety codes.
- Do not overload outlets and extension cords, which may cause fire or electrical shock.
- Do not place the camera near or in a place where the camera may contact overhead power lines, power circuits, or electrical lights.
- Ensure power conforms to SELV (Safety Extra Low Voltage) and that the limited power source is rated 16 VAC to 24 VAC, 12 VDC, or 24 VDC as specified in IEC60950-1. (Power supply requirement is subject to the device label).
- All input/output ports are SELV circuits. Ensure that SELV circuits are connected only to other SELV circuits.
- Ground the unit using the ground connection of the power supply to protect the unit from damage, especially in damp environments.
- Please install easy-to-use device for power off before installing wiring, which is for emergent power off when necessary.
- Protect the plug and power cord from foot traffic, being pinched, and its exit from the unit.
- Do not attempt to service the unit. Opening or removing covers may expose you to dangerous voltage or other hazards. Refer all servicing to qualified personnel.

- If the unit is damaged and requires service, unplug the unit from the main AC power supply and from the PoE supply and refer to qualified service personnel. Damage may include, but is not limited to:
 - The power supply cord or plug is damaged.
 - Liquid has spilled in or on the unit.
 - An object has fallen on the unit.
 - The unit has been dropped and the housing is damaged.
 - The unit displays a marked change in performance.
 - The unit does not operate in the expected manner when the user correctly follows the proper operating procedures.
- Ensure a service technician uses replacement parts specified by the manufacturer, or that have the same characteristics as the original parts. Unauthorized parts may cause fire, electrical shock, or other hazards. Dahua is not liable for any damage or harm caused by unauthorized modifications or repairs.
- Perform safety checks after completion of service or repairs to the unit.
- Use attachments and accessories only specified by the manufacturer. Any change or modification of the equipment, not expressly approved by Dahua, could void the warranty.
- Incorporate a readily accessible disconnect device in the building installation wiring for quick power disconnect to the camera.
- Dahua assumes no liability or responsibility for any fire or electrical shock caused by improper handling or installation.

Application Environment Requirements

- Please use the device within the allowed humidity (<95%RH) and altitude (<3000m).
- Transport, use, and store the unit within the specified temperature and humidity range.
- Do not place the unit in a wet, dusty, extremely hot or an extremely cold environment; and avoid environments with strong electromagnetic radiation or unstable lighting.
- Do not use the device in the corrosive environment such as high salt fog area (sea, beach and coastal area), acid gas environment and chemical plants.
- Do not use the device in applications with strong vibrations such as in boats and vehicles.
- Never push objects of any kind into this unit through openings as they may touch dangerous voltage points or cause a short circuit that may result in fire or electrical shock. Take care to not spill any liquid on the unit.
- If your installation environment is subjected to one of the conditions above, contact our sales staff to purchase cameras intended for the particular environment.
- Please don't install the device near the place with heat source, such as radiator, heater, stove or other heating equipment, which is to avoid fire.
- Do not aim the lens at an intense radiation source (such as the sun, a laser, and molten steel for example) to avoid damage to the thermal detector.
- Use the factory default package or material with equal quality to pack the device when transporting.

Operation and Maintenance Requirements

- Do not touch the heat dissipation component of the unit. This part of the unit is hot and may cause a burn.
- Do not open or dismantle the device; there are no components that a user can fix or replace. Opening the unit may cause water leakage or expose components to direct light. Contact the manufacturer or a qualified service representative to service the camera or to replace a component, including the desiccant.
- Dahua recommends the use of a thunder-proof device in concert with the unit.
- Do not touch the CCD or the CMOS optic sensor. Use a blower to clean dust or dirt on the lens surface. Use a dry cloth dampened with alcohol and gently wipe away any dust on the lens.
- Use a dry soft cloth to clean the unit's housing. If the unit is particularly dusty, use water to dilute a mild detergent, apply the diluted detergent to a soft cloth, then gently clean the device. Finally, use a dry cloth to wipe the unit dry. Do not use a volatile solvent like alcohol, benzene, or thinner; or use a strong detergent with abrasives, which may damage the surface coating or reduce the working performance of the unit.
- Do not touch or wipe a dome cover during installation, this cover is an optical device. Refer to the following methods clean the dome cover:
 - Stained with dirt: Use an oil-free soft brush or blower to gently remove the dirt.
 - Stained with grease or fingerprints: Use a soft cloth to wipe gently the water droplet or the oil from the dome cover. Then, use an oil-free cotton cloth or paper soaked with alcohol or detergent to clean the lens from the center of the dome to outside. Change the cloth several times to ensure the dome cover is clean.



WARNING

- Modify the default password after login.
- Use attachments and accessories only specified by the manufacturer. Any change or modification of the equipment, not expressly approved by Dahua, could void the warranty.
- Internal and external ground connection should be stable.
- Do not supply power via the Ethernet connection (PoE) when power is already supplied via the power connector.
- Disconnect power before device maintenance and overhaul. It is prohibited to open the cover with power on in an explosive environment.
- Please contact the local dealer or the nearest service center if the device fails to work normally, please don't dismantle or modify the device.

Cybersecurity Recommendations

Mandatory actions to be taken towards cybersecurity

- **Change Passwords and Use Strong Passwords**
 - The number one reason systems get “hacked” is due to having weak or default passwords. It is recommended to change default passwords immediately and choose a strong password whenever possible. A strong password should be made up of at least 8 characters and a combination of special characters, numbers, and upper and lower case letters.
- **Update Firmware**
 - As is standard procedure in the tech-industry, we recommend keeping NVR, DVR, and IP camera firmware up-to-date to ensure the system is current with the latest security patches and fixes.

Recommendations to improve your network security

- **Change Passwords Regularly**
 - The length should be greater than 8 characters;
 - Include at least two types of characters; character types include upper and lower case letters, numbers, and symbols;
 - Do not use an account name or the account name in reverse order;
 - Do not use sequential characters, such as 123, abc, etc.;
 - Do not use repeated characters, such as 111, aaa, etc.;
- **Change Default HTTP and TCP Ports**
 - Change default HTTP and TCP ports for systems. These are the two ports used to communicate and to view video feeds remotely.
 - These ports can be changed to any set of numbers between 1025 and 65535. Avoiding the default ports reduces the risk of outsiders being able to guess which ports you are using.
- **Update Firmware and Client Software**
 - Keep your network-enabled equipment (such as NVRs, DVRs, IP cameras, etc.) firmware up-to-date to ensure the system is equipped with the latest security patches and fixes. When the equipment is connected to the public network, it is recommended to enable the “auto-check for updates” function to obtain timely information of firmware updates released by the manufacturer.
 - Download and use the latest version of client software.
- **Enable HTTPS/SSL**
 - Set up an SSL Certificate and enable HTTPS to encrypt all communication between your devices and recorder.
- **Enable IP Filter**
 - Enable the IP filter to prevent unauthorized access to the system.

- **Change ONVIF Password**
 - Older IP camera firmware does not automatically change the ONVIF password when the system credentials are changed. Update the camera's firmware to the latest revision or manually change the ONVIF password.
- **Forward Only Ports You Need**
 - Forward only the HTTP and TCP ports that are required. Do not forward a wide range of numbers to the device. Do not DMZ the device's IP address.
 - Do not forward any ports for individual cameras if they are all connected to a recorder on site. Simply forward the NVR port.
- **Disable Auto-Login on SmartPSS**
 - Disable the Auto-Login feature on SmartPSS installed on a computer that is used by multiple people. Disabling auto-login prevents users without the appropriate credentials from accessing the system.
- **Use a Different Username and Password for SmartPSS**
 - Do not use a username/password combination that you have in use for other accounts, including social media, bank account, or email in case the account is compromised. Use a different username and password for your security system to make it difficult for an unauthorized user to gain access to the IP system.
- **Limit Features of Guest Accounts**
 - Ensure that each user has rights to features and functions they need to perform their job.
- **Disable Unnecessary Services and Choose Secure Modes**
 - Turn off specific services, such as SNMP, SMTP, and UPnP, to reduce network compromise from unused services.
 - It is recommended to use safe modes, including but not limited to the following services:
 - SNMP: Choose SNMP v3 and set up strong encryption passwords and authentication passwords.
 - SMTP: Choose TLS to access a mailbox server.
 - FTP: Choose SFTP and use strong passwords.
 - AP hotspot: Choose WPA2-PSK encryption mode and use strong passwords.
- **Multicast**
 - Multicast is used to share video streams between two recorders. Currently there are no known issues involving Multicast. Deactivate this feature if not in use to enhance network security.
- **Check the Log**
 - The information stored in the network log file is limited due to the equipment's limited storage capacity. Enable the network log function to ensure that the critical logs are synchronized to the network log server if saving log files is required.
 - Check the system log if you suspect that someone has gained unauthorized access to the system. The system log shows the IP addresses used to login to the system and the devices accessed.
- **Physically Lock Down the Device**
 - Perform physical protection to equipment, especially storage devices. For example, place the equipment in a special computer room and cabinet, and implement access control permission and key management to prevent unauthorized personnel from accessing the equipment.

- **Connect IP Cameras to the PoE Ports on the Back of an NVR**
 - Cameras connected to the PoE ports on the back of an NVR are isolated from the outside world and cannot be accessed directly.
- **Isolate NVR and IP Camera Network**
 - Ensure that the network for the NVR and IP cameras should not be the same network as a public computer network. Separate networks prevent unauthorized users accessing the same network the security system.
- **Secure Auditing**
 - Check online users regularly to ensure unauthorized accounts are not logged in to a device.
 - Check the equipment log to access the IP addresses used to login to devices and their key operations.







Table of Contents

Foreword	I
Important Safeguards and Warnings	IV
Cybersecurity Recommendations	VII
Table of Contents	X
1 Overview	1
1.1 Parts List	2
1.2 Dimensions.....	3
1.3 Cables and Connectors	4
2 Installing the Camera	5
2.1 Preparing for Installation	6
2.2 Unpacking	7
2.3 Installing an SD Card.....	8
2.4 Using the Waterproof Ethernet Connector.....	9
2.5 Mounting the Camera	10
2.5.1 Mounting to a Wall: Cables through Surface	10
2.5.2 Mounting to a Wall: Cables through Camera Base Conduit.....	11
3 Network Configuration	12
3.1 Initializing the Device.....	13
3.2 Modifying the IP Address	14
3.3 Connecting to the DMSS App	15

1 Overview

The Dahua 5 MP Starlight camera offers Smart Motion Detection for improved alarm accuracy from intrusion and tripwire functions. The camera is ideal for a host of diverse applications — Starlight, True Wide Dynamic Range, and IR illumination allow the camera to operate in any lighting condition. The camera is a component of the Dahua ArcticPro series and is rated to IP67 allowing the camera to deliver high-quality and reliable video in the harshest environments.

1.1 Parts List

Network Camera X 1	Screw Package X 1	Waterproof Connector X 1	Positioning Map X 1
			
Quick Start Guide X 1	CD-ROM/QR Code X 1	Wrench X 1 (Optional)	
			

1.2 Dimensions

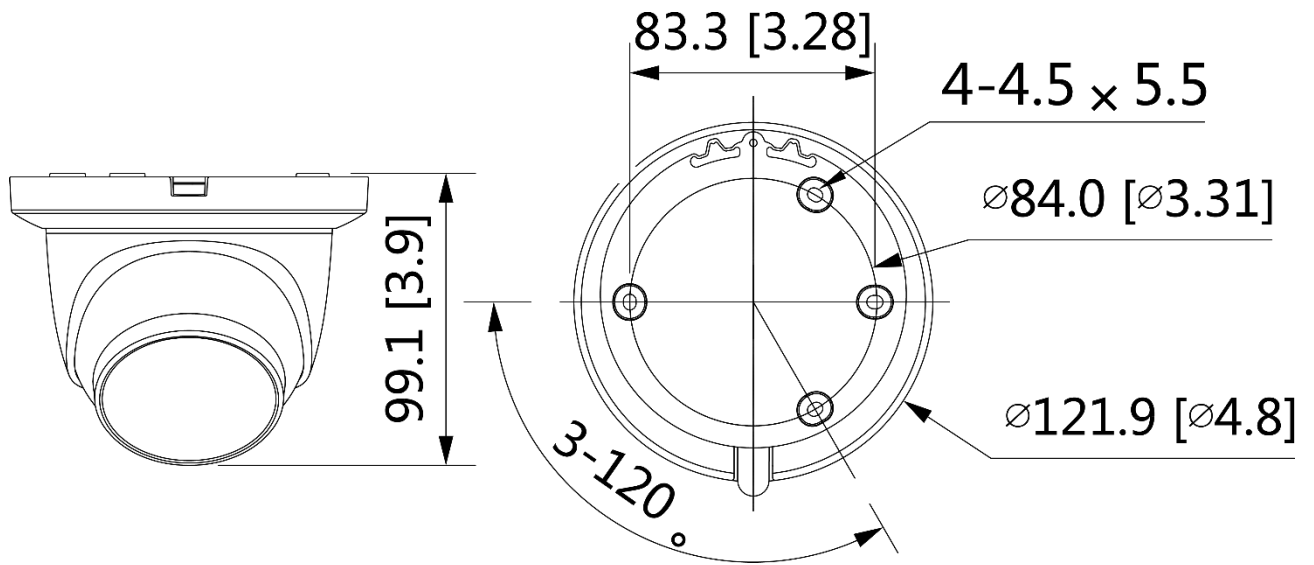

1.3 Cables and Connectors

- Cable type might vary with device.
- Waterproof all cable joints with insulating and waterproof tape to avoid short circuit and water damage.

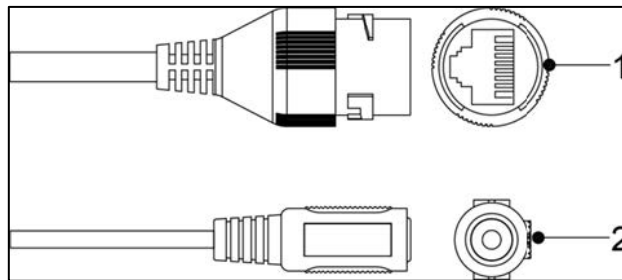

Ref.	Port Name	Connector	Description
1	Network Port	RJ-45	Connect to standard Ethernet cable. Note: Certain devices support Power over Ethernet. Check the specific device to determine if the device accepts PoE and use an appropriate Ethernet cable and network to supply power.
2	Power		Power port. Input 12 VDC power supply. Use in accordance with device label instructions.

2 Installing the Camera

This section details installing the camera to a wall or to a ceiling. Note that the wall or ceiling must be capable of supporting a minimum of three times the weight of the camera and a bracket (if used).

2.1 Preparing for Installation

- Make sure the mounting surface is strong enough to hold at least three times the total weight of camera and mounting hardware.
- **Warning:** DO NOT connect the camera to the power supply during installation.
- **Warning:** For units intended to be installed outdoors: All wiring connecting to the unit must be routed separately inside a different permanently earthed metal conduits (not supplied).
- **Warning:** Install external interconnecting cables in accordance to NEC, ANSI/NFPA70 (for US application) and Canadian Electrical Code, Part I, CSA C22.1 (for CAN application) and in accordance to local country codes for all other countries. Branch circuit protection incorporating a 20 A, 2-pole Listed Circuit Breaker or Branch Rated Fuses are required as part of the building installation. A readily accessible 2-pole disconnect device with a contact separation of at least 3 mm must be incorporated.
- **Warning:** DO NOT remove the protective film from the dome until the installation is complete to protect the dome from distortions from fingerprints, oil, grease or other contaminants.
- **Note:** Dahua recommends attaching a “drip loop” (flex or hard conduit) during installation to ensure condensation does not form in the mount or the conduit.

2.2 Unpacking

This equipment should be unpacked and handled with care. If an item appears to have sustained damage during shipping, notify the shipper immediately.

Verify that all the parts listed below are included. If an item is missing, contact customer support or your local representative.

The original packing carton is the safest container to transport the unit, in the event the unit must be returned for service. Retain the carton and all shipping material for future use.

2.3 Installing an SD Card

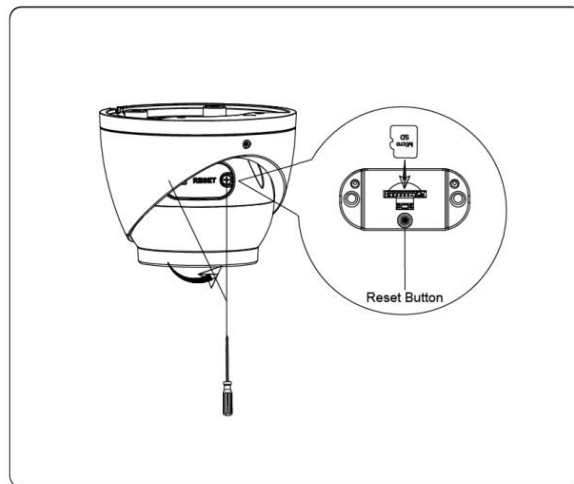

1. Disconnect power to the camera.
2. Remove the panel at the rear of the camera.
3. Gently insert the SD card into the slot until it clicks in place.
4. Replace the panel.
5. Press the Reset button for 10 seconds to reset the device.

2.4 Using the Waterproof Ethernet Connector

Attach the waterproof network connector if the camera is used outdoors.

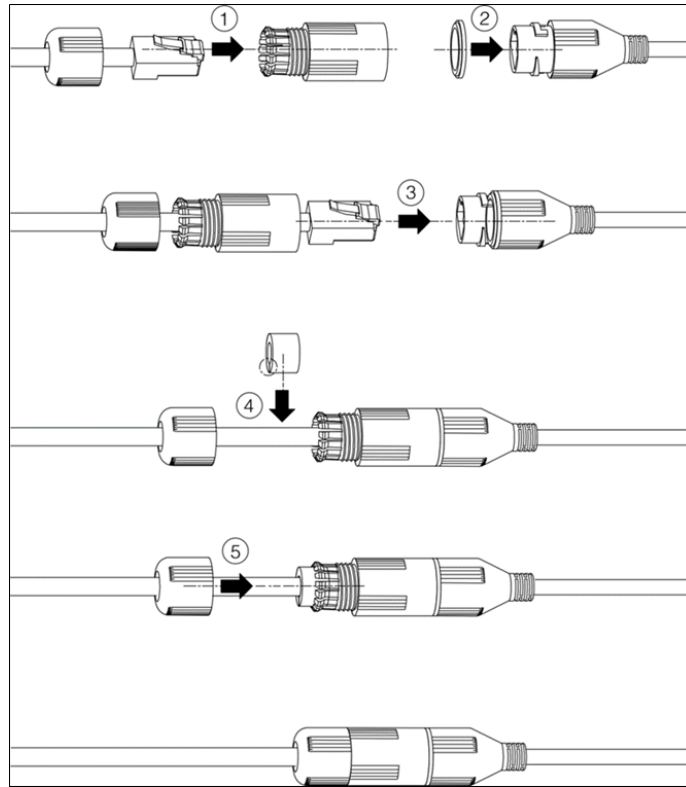

1. Place the wide side of the rubber ring onto the end of the network cable extending out from the camera.
2. Pull the waterproof cable end without the Ethernet connector through the body of the Waterproof Connector. Thread the cable through the Fixing Rubber Ring and the Waterproof Locking Cover.
3. Attach the male Ethernet connector to the network cable coming from the camera. Ensure the Waterproof Connector shroud covers the Ethernet connection.
4. Connect the other end of the waterproof connector to the network port and rotate it clockwise to lock the network port and waterproof connector firmly.
5. Slide the Waterproof Locking Cover over the main body of waterproof connector and rotate it clockwise to seal the connection.

2.5 Mounting the Camera

1. Remove the camera, the mounting template, and the hardware package from the box.
2. Apply the mounting template to the installation medium. Pre-drill the three (3) perimeter holes for the expansion bolts, using a drill bit that is no wider than the expansion bolt.
3. Detach the camera body from the installation base. Use a T10 driver to remove the Torx fastener from the front of the camera. Carefully remove the camera body and housing from the base.
4. Determine the wire route, either through the installation medium or through side conduit on the camera base. Refer to the illustrations below.
5. Drill a center hole to route the cables from the camera through the installation medium.
6. Insert an expansion bolt into each pre-drilled perimeter hole.
7. Secure the installation base to the installation medium with the three screws.
8. Route the cables from the back of the camera through the installation medium or via the camera base conduit and align the three (3) holes on the base of the camera with the expansion bolts.
9. Fit the camera body into the installation base and then place the housing over the camera.
10. Secure the camera body and housing to the installation base with the T10 fastener.
11. Connect the external cables from the camera to the appropriate cables for Ethernet and power.

2.5.1 Mounting to a Wall: Cables through Surface

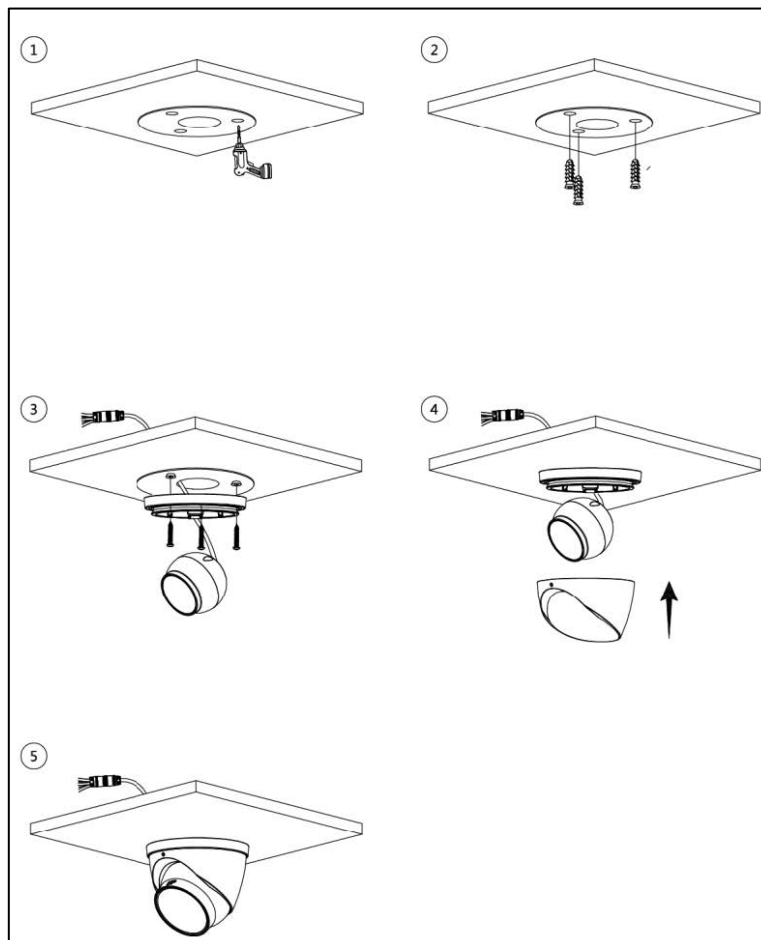

2.5.2 Mounting to a Wall: Cables through Camera Base Conduit

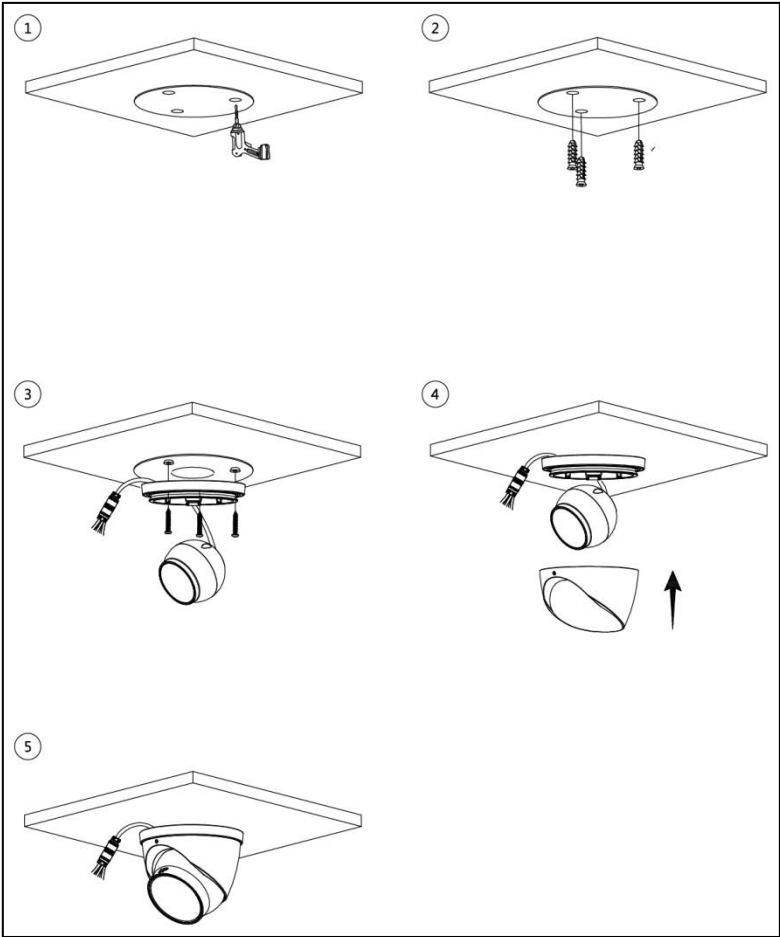

3 Network Configuration

Initialize the device configure the IP setting with the Dahua ConfigTool or via the device's web interface.

- Device initialization is available on select models, and it is required at first use and after device is being reset.
- Device initialization is available only when the IP addresses of the device (192.168.1.108 by default) and the PC are on the same network segment.
- The following figures and interfaces are for reference only, and the actual product shall prevail.

3.1 Initializing the Device

1. Double-click the ConfigTool Icon on a PC to open the tool.
2. Click the IP Icon.

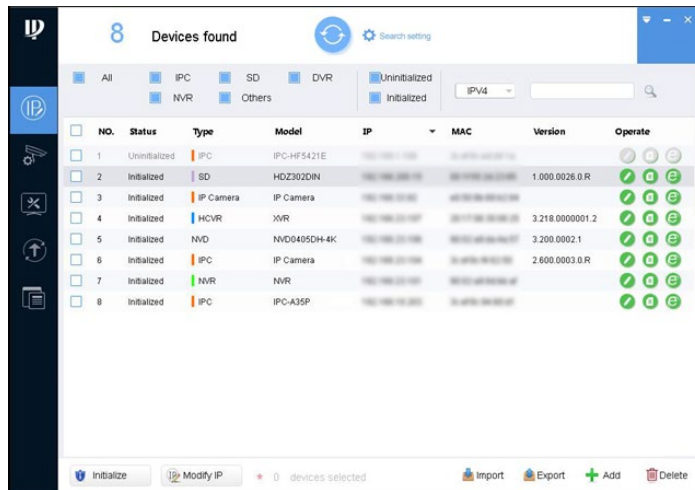

3. Click Search Setting.
4. Enter the start IP and end IP of the network segment in which you want to search devices, and then click OK. All the devices found in the network segment are listed.
5. Select one or several devices with status Uninitialized, and then click Initialize.
6. Select the appropriate devices and click Initialize.

Device initialization

1 device(s) have not been initialized

Username: admin

New Password: []
Weak Medium Strong

Confirm Password: []

Use a password that has 8 to 32 characters, it can be a combination of letter(s), number(s) and symbol(s) with at least two kinds of them. (excluding " ", " ", " ", " ", " ", " ", " ", " ")

Email Address: [] (for password reset)

*After you have set new password, please set password again in Search Setup.

Next

7. Set and confirm the password of the devices, and then enter a valid email address. Click Next.
8. Select the options according to your needs and then click OK.
9. Click Finish.

3.2 Modifying the IP Address

- Modify the IP address of one or multiple devices at one time. This section provides instructions for modifying IP addresses in batch.
 - Modifying IP addresses in batch is available only when the corresponding devices have the same login password.
1. Follow steps 1 through 4 in the section above to initialize the device and to search for devices in your network segment. Ensure the username and password are the same as set during the device initialization.
 2. Select the devices whose IP addresses need to be modified, and then click Modify IP.



3. Select Static mode and enter start IP, subnet mask, and gateway.
 - IP addresses of multiple devices will be set to the same if you select Same IP.
 - If DHCP server is available in the network, devices will automatically obtain IP addresses from DHCP server when you select DHCP.
4. Click OK.

3.3 Connecting to the DMSS App

1. Install the free mobile app on your smart phone:
 - Apple App Store: iDMSS
 - Google Play Store: gDMSS
2. Tap the iDMSS or the gDMSS icon to open the app.
3. Tap the Device icon at the bottom of the screen.

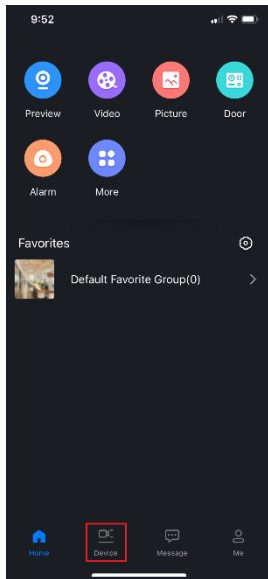

4. Tap the “+” icon at the upper-left corner of the screen and then tap SN/Scan to add the device.

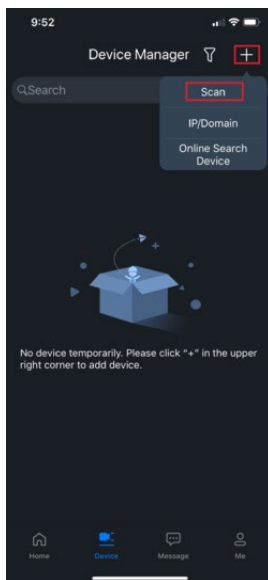

5. Select Wired Camera.

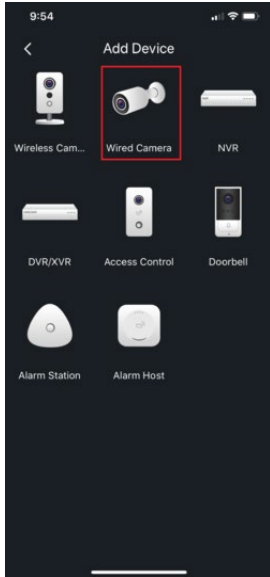

6. Scan the QR code on the the back or bottom of the device. If the QR code does not work, tap Manually enter SN.

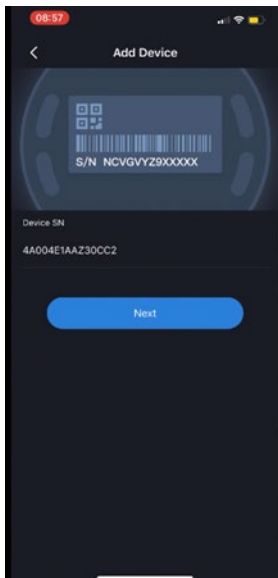

7. Input the device for easy identification. It's required to input the password for the added device then select the save icon located on the top right corner.

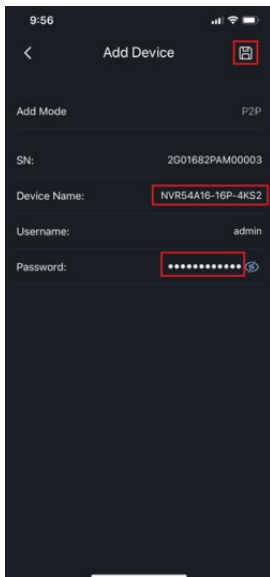



Dahua Technology USA

23 Hubble

Irvine, CA 92618

Tel: (949) 679-7777

Fax: (949) 679-5760

Support: 877-606-1590

Sales: sales.usa@dahuatech.com

Support: support.usa@dahuatech.com