

4MP Fixed-focal Bullet WizSense Network Camera

Fixed-focal Network Camera with Smart Dual Illumination and Analytics+



WizSense

VU-MORE

WizSense Series devices combine Dahua's powerful Analytics+ with an intuitive and easy to use interface. WizSense devices offer Smart Motion Detection and Perimeter Protection functions that focus on human and vehicular images and ignore irrelevant images to capture important video while reducing false alarms. WizSense Series devices provide powerful general surveillance for small to medium size businesses at a sensible price.

System Overview

The Dahua VU-MORE Color Lite Series camera offers multiple features such as motion detection and Smart Dual Illumination to provide deterrence, overtness, and full-color video. The camera provides increased color viewing at night for a variety of small to mid-size applications at an affordable price.

Functions

Perimeter Protection

Dahua Analytics+ includes Tripwire and Intrusion functions that offer custom tripwires based on object type for automation in limited access areas. Perimeter Protection requires less pixels to detect an object to deliver improved accuracy and decreased false alarms due to lights, weather, trees, or animals.

Smart Motion Detection+

Smart Motion Detection, a component of Dahua's Analytics+ technology, improves alarm accuracy and decreases the number of false alarms. The advanced SMD algorithm analyzes a scene for human or vehicle motion, while filtering out other motion due to trees, leaves, animals, weather, and triggers an alarm when detected.

Smart H.265+

Smart H.265+ is the optimized implementation of the H.265 codec that uses a scene-adaptive encoding strategy, dynamic GOP, dynamic ROI, flexible multi-frame reference structure and intelligent noise reduction to deliver high-quality video without straining the network. Smart H.265+ technology reduces bit rate and storage requirements by up to 70% when compared to standard H.265 video compression.

Wide Dynamic Range (WDR)

The camera achieves vivid images, even in the most intense contrast lighting conditions, using industry-leading wide dynamic range (WDR)

- 1/3-in. 4MP Progressive-scan CMOS Sensor
- 4MP at 20 fps Maximum Resolution, 2.8 mm Fixed Lens
- Analytics+ Function – Perimeter Protection and Smart Motion Detection+
- Dual Stream Encoding
- Smart Dual Illumination — IR and White Light
- Smart H.265+ and Smart H.264+ Dual Codecs
- True WDR (120 dB) and Day/Night (ICR)
- Maximum IR LED Length 30 m (98.43 ft) with Smart IR
- Intelligent Video System
- IP67 Ingress Protection
- Five-year Warranty*



technology. For applications with both bright and low lighting conditions that change quickly, True WDR (120 dB) optimizes both the bright and dark areas of a scene at the same time to provide usable video.

Smart Dual Illuminators

The camera offers both IR and white-light illuminators and intelligently employs each depending on the situation. Typically, the camera enters the IR mode as ambient light decreases. When the camera detects a person entering the monitoring area, it activates the white-light illuminator to capture full-color details. Once the person leaves the area, the camera switches back to IR illumination.

Intelligent Video System

IVS is a built-in video analytic algorithm that delivers intelligent functions to monitor a scene for Tripwire violations and intrusion detection. A camera with IVS quickly and accurately responds to monitoring events in a specific area and offers tamper detection by recognizing a dramatic scene change and generating a warning message to inspect the camera.

Smart IR Technology

With IR illumination, detailed images can be captured in low light or total darkness. The camera's Smart IR technology adjusts the intensity of the camera's infrared LEDs to compensate for the distance of an object. Smart IR technology prevents IR LEDs from whitening out images as they come closer to the camera. The camera's integrated infrared illumination provides high-performance in extreme low-light environments up to 30 m (98.43 ft).

Cybersecurity

Dahua network cameras are equipped with a series of key cybersecurity technologies including: security authentication and authorization, access control, trusted protection, encrypted transmission, and encrypted storage. These technologies improve the camera's ability to prevent malicious access and to protect data.

Environmental IP67

Subjected to rigorous dust and water immersion tests the camera suitable for the most demanding outdoor applications. The camera carries an IP67 rating that ensures protection from total dust ingress and protection from water immersion between 15 centimeters and 1 meter in depth.

Technical Specification

Camera

Image Sensor	1/3-in. CMOS
Effective Pixels	2688 (H) × 1520 (V), 4MP
Scanning System	Progressive
RAM/ROM	128 MB/128 MB
Electronic Shutter Speed	Auto, Manual, 1/3 s to 1/100,000 s
Minimum Illumination	0.008 lux at F1.6 (Color, 30 IRE) 0.0008 lux at F1.6 (B/W, 30 IRE) 0 lux (Illuminator on)
S/N Ratio	> 56 dB
IR Distance	30 m (98.43 ft) (IR), 15 m (49.21 ft) (Warm light)
IR On/Off Control	Auto; Manual
Illuminators	One (1) IR LED One (1) Warm Light

Lens

Lens Type	Fixed-focal			
Iris Type	Fixed			
Mount Type	M12			
Focal Length	2.8 mm			
Maximum Aperture	F1.6			
Angle of View	Horizontal	95°		
	Vertical	52°		
	Diagonal	114°		
Close Focus Distance	0.9 m (2.95 ft)			
DORI ¹ Distance	Detect	Observe	Recognize	Identify
	63.6 m (208.66 ft)	25.4 m (83.33 ft)	12.7 m (41.67 ft)	6.4 m (20.99 ft)

Pan / Tilt / Rotation

Pan/Tilt/Rotation	Pan: 0° to 360° Tilt: 0° to 90° Rotation: 0° to 360°
-------------------	--

Video

Compression	Smart H.265+, Smart H.264+, H.264H, H.265, H.264, H.264B, MJPEG (Only supported by the sub stream)	
Streaming Capability	Two (2) Streams	
Resolution	4MP (2688 × 1520), 3.6MP (2560 × 1440), 3MP (2304 × 1296), 1080p (1920 × 1080), 1.3MP (1280 × 960), 720p (1280 × 720), D1 (704 × 480), VGA (640 × 480), CIF (352 × 240)	
Frame Rate	Main Stream	2688 × 1520 at 20 fps
	Sub Stream	704 × 480 at 20 fps
Bit Rate	H.264: 32 kbps to 6144 kbps H.265: 12 kbps to 6144 kbps	
Bit Rate Control	CBR, VBR	
Day/Night	Auto (ICR); Manual	
BLC Mode	BLC, HLC, WDR (120 dB)	
White Balance	Auto, Natural, Street Lamp, Outdoor, Manual, Regional Custom	
Gain Control	Auto, Gain Priority, Shutter Priority, Manual	
Noise Reduction	3DNR	
Motion Detection	Off, On (4 Zones, Rectangle)	
Region of Interest	Off, On (4 Zones)	

Smart IR	Supported
Image Rotation	0°, 90°, 180°, 270°
Mirror	Off, On
Privacy Masking	Off, On (4 Areas, Rectangle)

Audio

Built-in MIC	Yes
Audio Compression	G.711a, G.711Mu, PCM, G.726

Network

Ethernet	RJ-45 (10/100 Base-T)
Protocol	IPv4, IPv6, HTTP, TCP, UDP, ARP, RTP, RTSP, RTCP, RTMP, SMTP, FTP, SFTP, DHCP, DNS, DDNS, NTP, Multicast, ICMP, IGMP
Interoperability	ONVIF (Profile S, Profile T), CGI, P2P, Milestone, SDK, API
Maximum User Access	6 (Total bandwidth: 36 M)
Edge Storage	FTP, SFTP Micro SD Card Slot (Maximum 256 GB)
Web Viewer	IE, Chrome, Firefox
Management Software	DSS, DMSS
Mobile Operating System	iOS, Android
Cyber Security	Configuraton Encrypton, Trusted Executon, Digest, Security Logs, WSSE, Account Lockout, Syslog, Video Encrypton, 802.1x, IP/MAC Filtering, HTTPS, Trusted Upgrade, Trusted Boot, Firmware Encrypton, Generating and Importing X.509 Certificaton

Certifications

Safety	EN 62368-1
Electromagnetic Compatibility (EMC)	FCC CFR 47 Part 15 Subpart B Electromagnetic Compatibility Directive 2014/30/EU

Electrical

Power Supply	12 VDC or PoE (802.3af)
Power Consumption	Basic: 1.9 W (12 VDC), 2.4 W (PoE); Maximum: 5.2 W (12 VDC), 5.9 W (PoE) (H.265 + Intelligence + WDR + Warm Light)

Environmental

Operating Conditions	-40°C to +60°C (-40°F to +140°F), Less than 95% RH
Storage Conditions	-40°C to +60°C (-40°F to +140°F)
Ingress Protection	IP67

Construction

Casing	Metal
Dimensions	166.2 mm × 70 mm (6.54 in. × 2.76 in.)
Net Weight	0.48 kg (1.06 lb)
Gross Weight	0.57 kg (1.26 lb)

Analytics+ Functions

Perimeter Protection	<ul style="list-style-type: none"> Detects human or vehicle violations using the following methods: <ul style="list-style-type: none"> Tripwire: a target crosses a defined line. Intrusion: a target enters or exits a defined perimeter. Monitors a combination of detection methods. Search and retrieve video based on target type.
Intelligent Search	Works with a Smart NVR to perform and refine intelligent searches, event extraction and merging to event videos

1. The DORI distance is a measure of the general proximity for a specific classification to help pinpoint the right camera for your needs. The DORI distance is calculated based on sensor specifications and lab test results according to EN 62676-4, the standard that defines the criteria for the Detect, Observe, Recognize and Identify classifications..

Smart Motion Detection+ ²	<ul style="list-style-type: none"> • Differentiates between and classifies human and vehicle objects. • Filters false alarms due to leaves, lights, animals, and other inconsequential objects. • Extracts human or vehicle objects from recorded video for quick target search and retrieval.
--------------------------------------	---

Intelligent Video System Functions

IVS triggers an alarm and takes a defined action for the following events:

Standard Features	<ul style="list-style-type: none"> • Tampering with the camera. • Error writing to an onboard Micro SD card. • Error sending or receiving data over the network. • Unauthorized access to the camera. • IP Address Conflict
-------------------	--

Ordering Information

Type	Part Number	Description
4MP Camera	N42DDS2	4MP VU-MORE COLOR Fixed-focal Bullet WizSense Network Camera
Accessories (Optional)	PFA134	Junction Box
	PFA151	Corner Mount (use with PFA134 junction box)
	PFA152-E	Pole Mount
	DH-PFM321D-US	12V 1A Power Adapter
	DHI-TF-P100 Series	Micro SDXC Cards (64 GB, 128 GB, or 256 GB)
	DH-PFM920I-5EU-U	305 m (1000 ft) CAT5e UTP Cable

Accessories (Optional)



PFA134
Junction Box

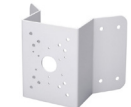

PFA151
Corner Mount



PFA152-E
Pole Mount



DH-PFM321D-US
12 VDC, 1 A
Power Adapter



DHI-TF-P100 Series
Micro SDXC Cards
(64 GB, 128 GB, or
256 GB)

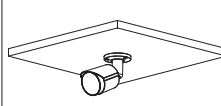
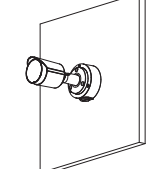
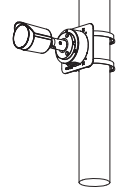

DH-PFM920I-5EU-U
305 m (1000 ft)
CAT5e UTP Cable

Ceiling Mount	Junction Mount	Pole Mount (Vertical)
No Accessory	PFA134	PFA134 + PFA152-E
		

Dimensions

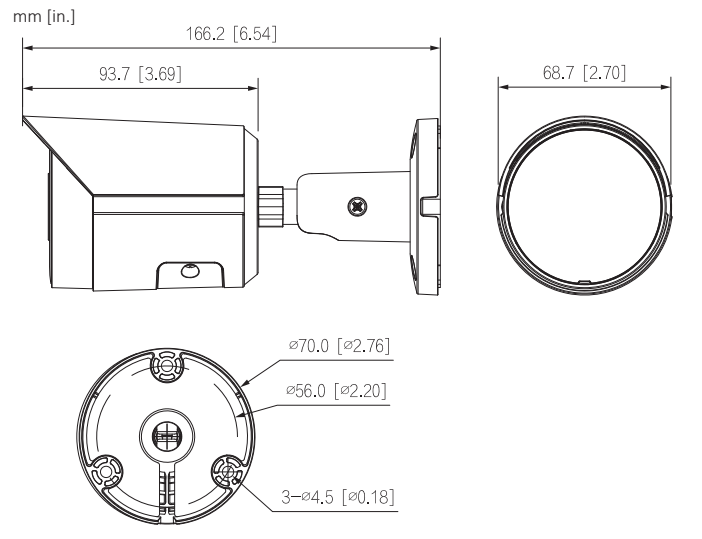

2. Pair a Smart Motion Detection camera with a Dahua recording device that also offers SMD functionality to take advantage of SMD alarm filtering and object classification when searching and playing back recorded video.

